

Technical Data Sheet

TANSY (SERIES)

Code: BSP-002

Product: One Way Bath Spout



BSP-002
Chrome

Line Drawing:

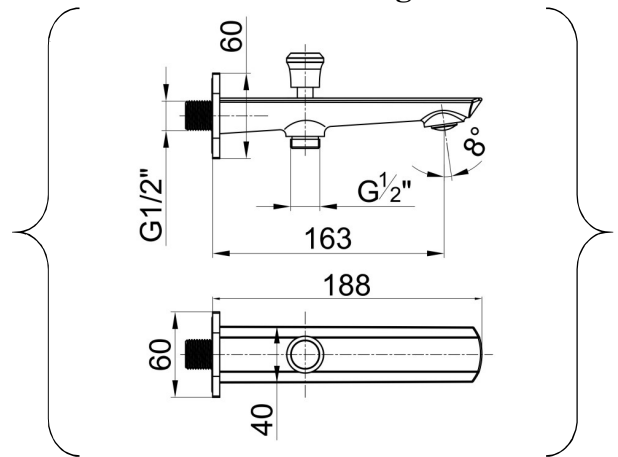

Product Description:

- * Brass ingots quality standard GB/T2059-2008.
- * CASS 4H/AASS 48 by standard procedure ASTM B117/ASTM B 368/09 JIS Z 2371/ISO.
- * Neoperl (USA) Aerator M24x1.
- * Flow Rate: 15.7L/min at 3 bar. (Water saving designs available based on request).
- * Inlet Thread Size G1/2.

Plating:

- * Total plating thickness for Brass: 12.3 microns to 12.5 microns.
- * Semi bright and bright nickel: 12 microns.
- * Chrome: 0.3 to 0.5 microns.

This TDS supersedes those Issued previously.

Contents in this data sheet subject to change when required.

Please contact our nearest marketing executive/dealer for more details.