

## Technical Data Sheet

### TANSY SERIES

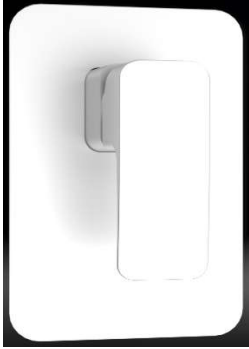

**Part No: DWG-SLSM-3101**  
Chrome

**Code: TAN-40016**

**Product: 3/4" 3 WAY SHOWER MIXER (BRASS DISC)**

### Line Drawing:

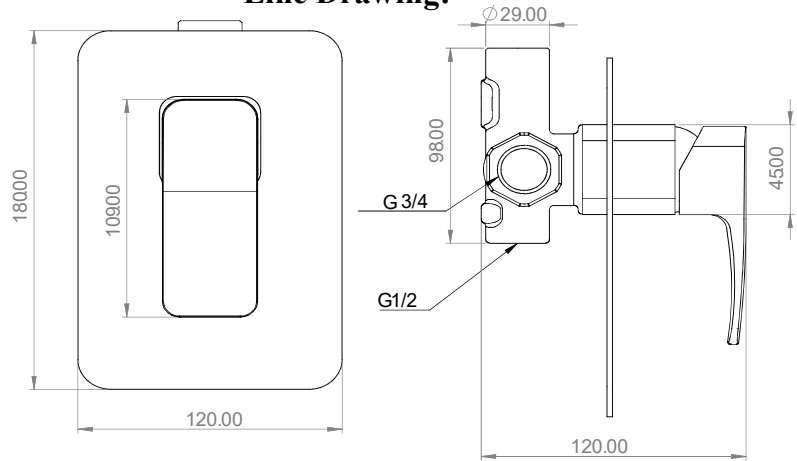

### Product Description:

- \* KN-40 Ceramic mixing cartridges conventional single-lever type 40 mm sizes.
- \* Brass ingots quality standard EN 1980.
- \* CASS 4H/AASS 48 by standard procedure ASTM B117/ASTM B 368/09 JIS Z 2371/ISO.
- \* Product specifications EN 817 for cartridges (Life endurance up to 70000 cycles).
- \* Product Specifications ASME A112.18.1M for cartridges (Life endurance up to 500000 cycles).
- \* Pressure Test For Cartridge Passed: 3bar/45psi-EN817.
- \* Cartridge Flow Rate: 40.9 l/min / 10.8 gpm without resistance  
23.6 l/min / 6.2 gpm with resistance „C”
- \* Inlet Thread Size G3/4.

### Plating:

- \* Total plating thickness for Brass Faucet :  
12.3 microns to 12.5 microns.
- \* Semi bright and bright nickel: 12 microns.
- \* Chrome: 0.3 to 0.5 microns.

# This TDS supersedes those Issued previously.  
# Contents in this data sheet subject to change when required.  
# Please contact our nearest marketing executive/dealer for more details.