

Technical Data Sheet

CORDELIA SERIES



Part No: DWG-TDSM-4101
Chrome

Code: TAN-40018

**Product: 1/2" 4 WAY TURN DIVERTER
SHOWER MIXER (SS DISC)**

Line Drawing:

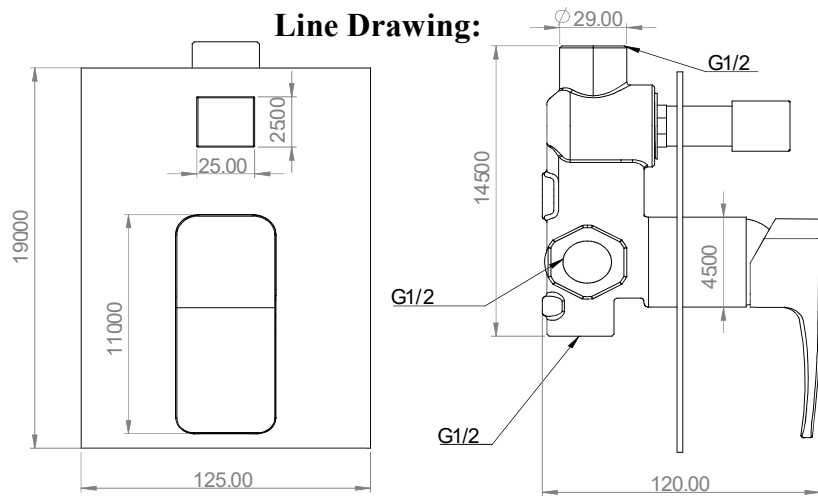

Product Description:

- * KN-40 Ceramic mixing cartridges conventional single-lever type 40 mm sizes.
- * Brass ingots quality standard EN 1980.
- * CASS 4H/AASS 48 by standard procedure ASTM B117/ASTM B 368/09 JIS Z 2371/ISO.
- * Product specifications EN 817 for cartridges (Life endurance up to 70000 cycles).
- * Product Specifications ASME A112.18.1M for cartridges (Life endurance up to 500000 cycles).
- * Pressure Test For Cartridge Passed: 3bar/45psi-EN817.
- * Cartridge Flow Rate: 40.9 l/min / 10.8 gpm without resistance
23.6 l/min / 6.2 gpm with resistance „C”
- * Inlet Thread Size G1/2.

Plating:

- * Total plating thickness for Brass Faucet :
12.3 microns to 12.5 microns.
- * Semi bright and bright nickel: 12 microns.
- * Chrome: 0.3 to 0.5 microns.

This TDS supersedes those Issued previously.
Contents in this data sheet subject to change when required.
Please contact our nearest marketing executive/dealer for more details.